

Kxxx1G Series

RoHS

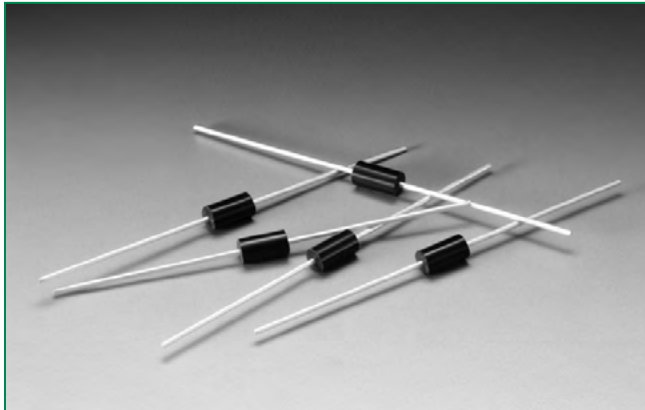

Schematic Symbol

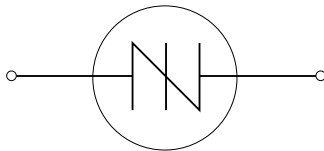

Applications

Typical application circuit presented in Figure 10 of this data sheet (Typical Metal Halide Ignitor Circuit).

Description

The Multipulse™ SIDAC is a voltage switch used in Metal-Halide lamp ignition circuits as well as High Pressure Sodium lamp ignition circuits for outdoor street and area lighting. This robust solid state switch is designed to handle lamp igniter applications requiring operation at ambient temperatures up to 90°C where igniter circuit components can raise SIDAC junction temperature up to 125°C, especially when the lamp element is removed or ruptured. Its excellent commutation time (t_{COMM}) makes this robust product best suited for producing multiple pulses in each half cycle of 50/60 Hz line voltage. The Multipulse™ SIDAC is offered in DO-15 axial leaded package.

Kxxx1G SIDAC has a repetitive off-state blocking voltage (V_{DRM}) of 180V to 270V minimum depending actual device type. Blocking capability is ensured by glass passivated junctions for best reliability. Package is epoxy encapsulation with tin-plated copper alloy leads.

Features

- AC circuit oriented
- RoHS Compliant
- Triggering Voltage of 200 to 380V

Electrical Specifications

Symbol	Parameters	Test Conditions	Min	Max	Unit
V_{BO}	Breakover/Trigger Voltage	K2201G K2401G K2501G K3601G	200 220 240 340	230 250 280 380	V
V_{DRM}	Repetitive Peak Off-State Voltage	K2201G K2401G K2501G K3601G	180 190 200 270		V
$I_{T(RMS)}$	On-State RMS Current, $T_J < 125^\circ\text{C}$	50/60Hz Sine Wave		1	A
I_H	Dynamic Holding Current, $R=100\ \Omega$	50/60Hz Sine Wave		120 TYP	mA
R_s	Switching Resistance, $R_s = \frac{(V_{BO} - V_s)}{(I_s - I_{BO})}$	50/60Hz Sine Wave	100		Ω
t_{COMM}	Commutation Time $T_J < 125^\circ\text{C}$	See test circuit and waveform in Figure 9		100	μsec
I_{BO}	Breakover Current	50/60Hz Sine Wave		10	μA
I_{TSM}	Non-repetitive 1 cycle On-State peak value	60Hz 50Hz		20.0 16.7	A
di/dt	Critical Rate of Rise of On-State Current			150	A/ μsec
dv/dt	Critical Rate of Rise of Off-State Voltage			1500	V/ μsec
T_s	Storage Temperature Range		-40	+125	$^\circ\text{C}$
T_J	Max Operating Junction Temperature		-40	+125	$^\circ\text{C}$
$R_{\theta JL}$	Thermal Resistance	Junction to lead		18	$^\circ\text{C/W}$

Figure 1: Characteristics

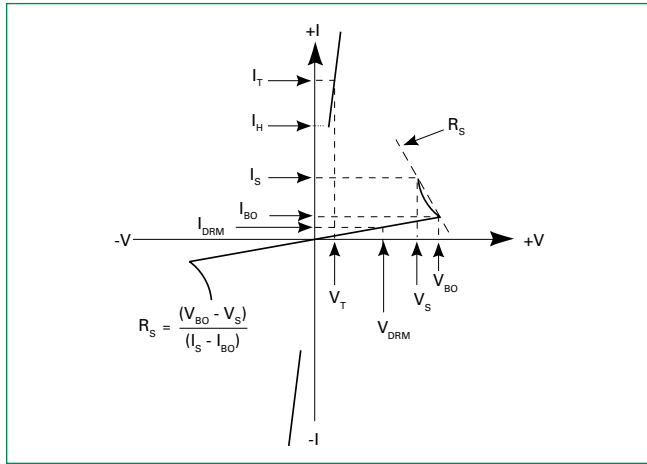

Figure 2: Maximum Allowable Lead/Tab Temperature vs. On-State Current

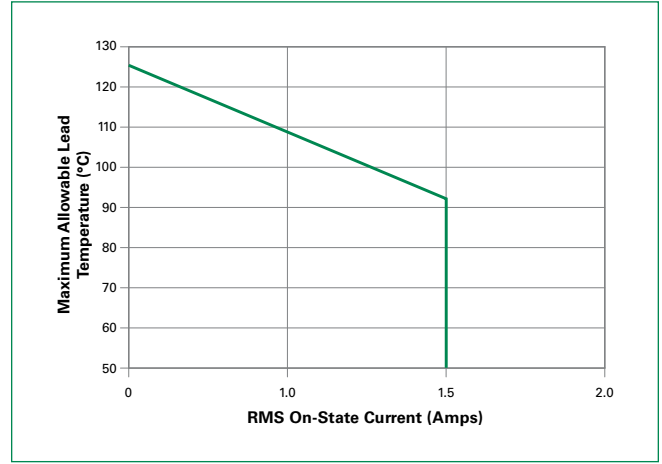

Figure 3: Power Dissipation (Typical) vs. On-State Current

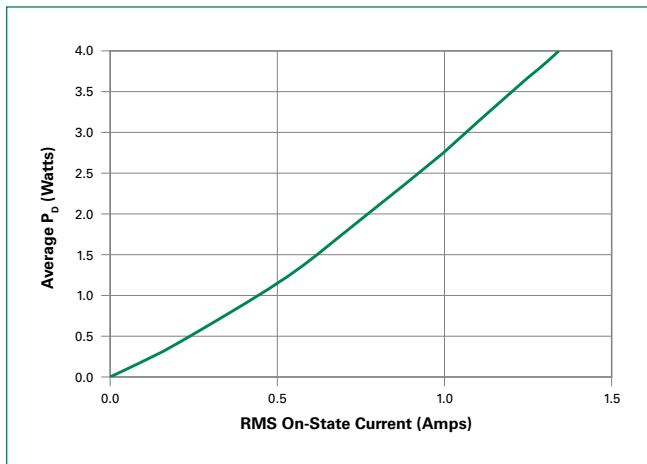

Figure 4: V_{BO} Change vs. Junction Temperature

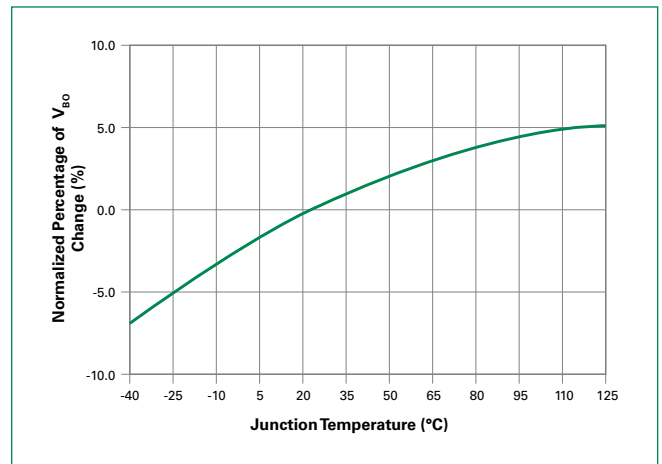

Figure 5: Pulse On-State Current Rating

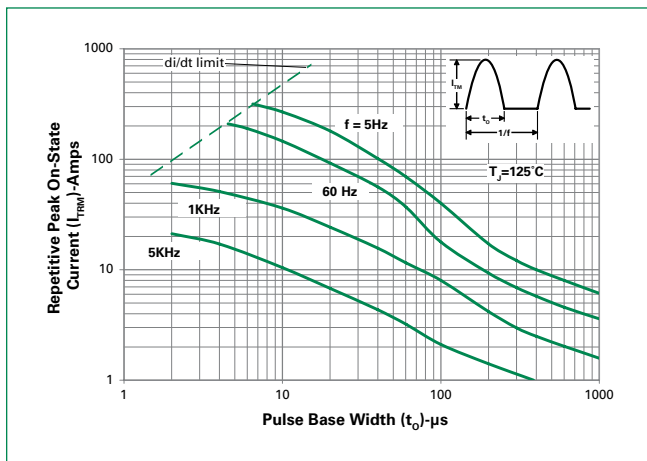

Figure 6: Maximum Allowable Ambient Temperature vs. On-State Current

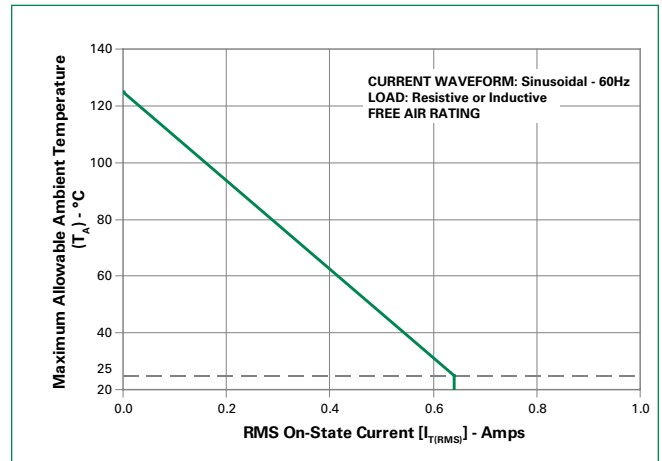

Figure 7: Peak Surge Current vs Surge Current Duration

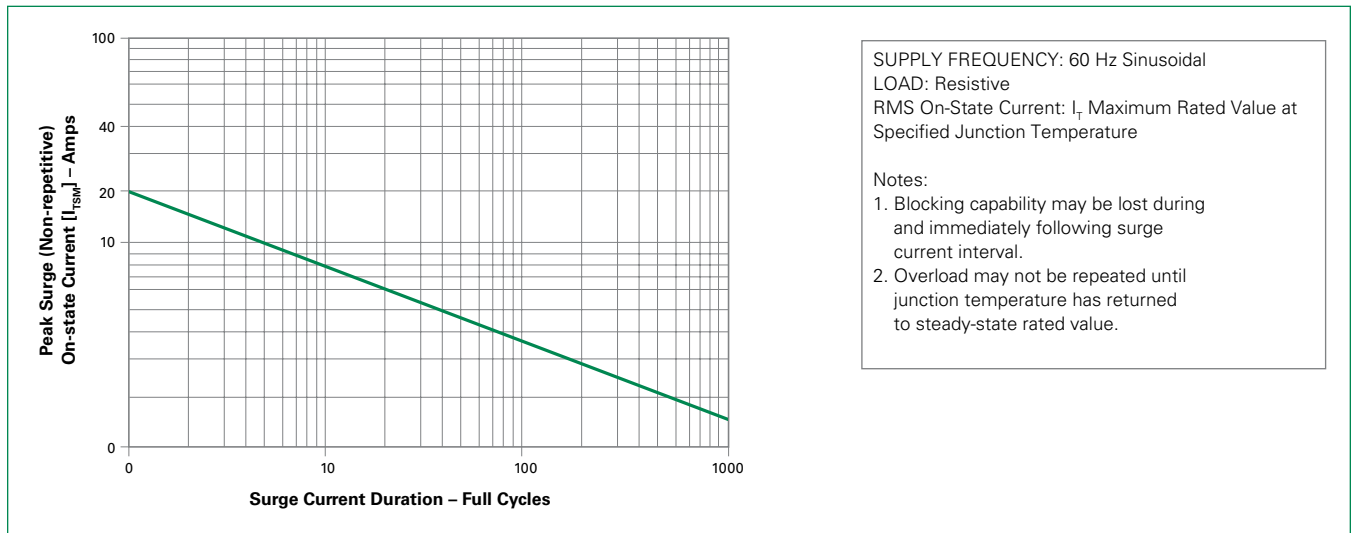

Figure 8: Typical On-State Voltage vs On-State Current

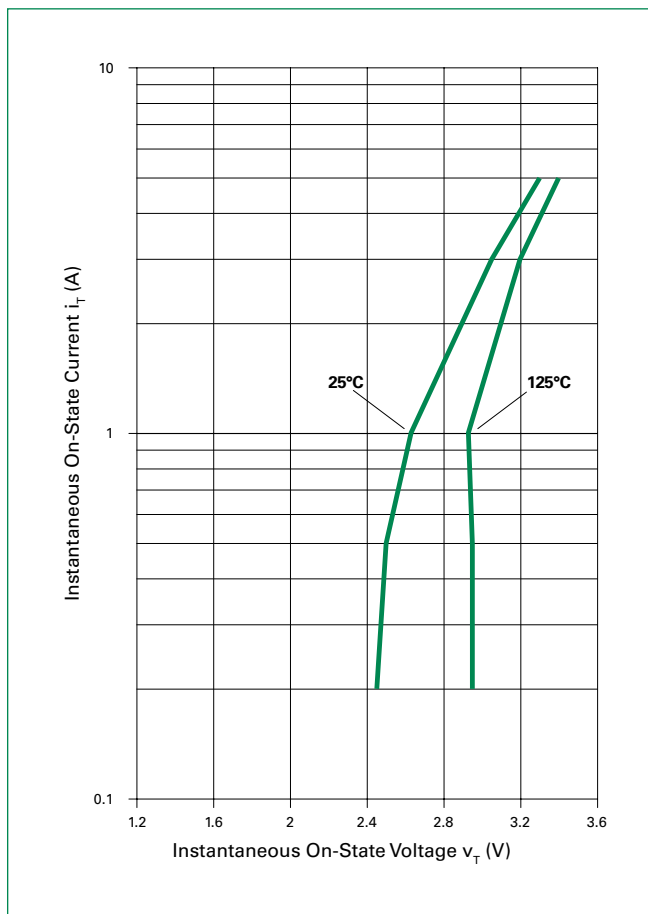

Figure 9: Multipulse™ SIDAC t_{COMM} , Commutation Time

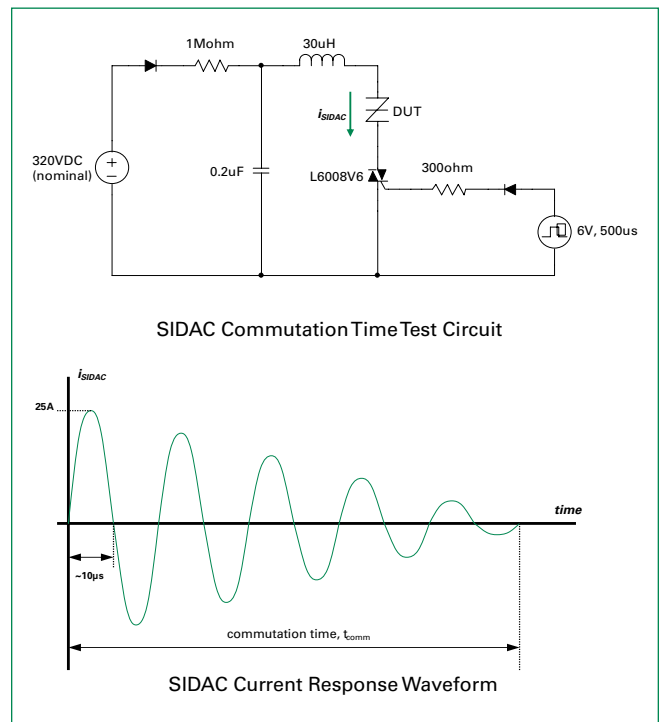
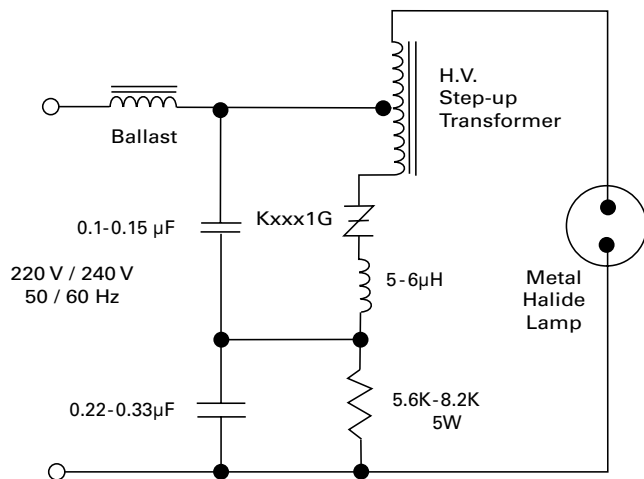

Figure 10: Typical Metal Halide Ignitor Circuit



Note: With proper component selection, this circuit will produce three pulses for ignition of metal halide lamp that requires a minimum of three pulses at 4kV magnitude and >1uSec duration each at a minimum repetition rate of 3.3kHz.

Soldering Parameters

Reflow Condition		Pb – Free assembly
Pre Heat	- Temperature Min ($T_{s(min)}$)	150°C
	- Temperature Max ($T_{s(max)}$)	200°C
	- Time (min to max) (t_s)	60 – 180 secs
Average ramp up rate (Liquidus Temp (T_L) to peak)		5°C/second max
$T_{s(max)}$ to T_L - Ramp-up Rate		5°C/second max
Reflow	- Temperature (T_L) (Liquidus)	217°C
	- Temperature (t_L)	60 – 150 seconds
Peak Temperature (T_p)		260 ^{+0/-5} °C
Time within 5°C of actual peak Temperature (t_p)		20 – 40 seconds
Ramp-down Rate		5°C/second max
Time 25°C to peak Temperature (T_p)		8 minutes Max.
Do not exceed		280°C

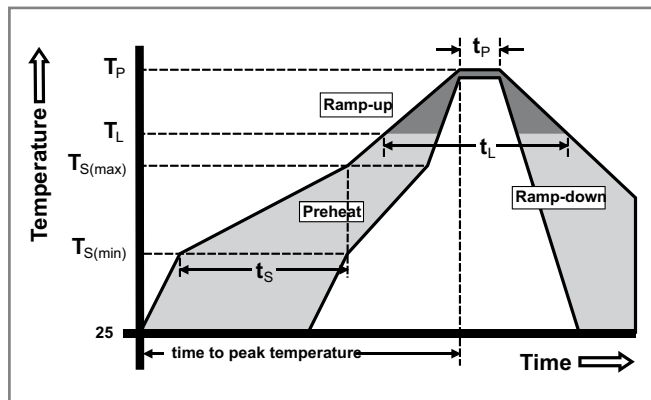

Physical Specifications

Terminal Finish	100% Matte Tin Plated
Body Material	UL recognized epoxy meeting flammability classification 94V-0
Lead Material	Copper Alloy

Package	Weight / unit (mg)
DO-15	385

Design Considerations

Careful selection of the correct device for the application's operating parameters and environment will go a long way toward extending the operating life of the Thyristor. Overheating and surge currents are the main killers of SIDACs. Correct mounting, soldering, and forming of the leads also help protect against component damage.

Reliability/Environmental Tests

Test	Specifications and Conditions
High Temperature Voltage Blocking	MIL-STD-750: Method 1040, Condition A Rated V_{DRM} (VAC-peak), 125°C, 1008 hours
Temperature Cycling	MIL-STD-750: Method 1051, 100 cycles; -40°C to 150°C, 15-minute dwell time
Temperature / Humidity	EIA/JEDEC: JESD22-A101 1008 hours; 160V - DC: 85°C; 85% relative humidity
High Temp Storage	MIL-STD-750: Method 1031 150°C, 1008 hours
Low-Temp Storage	-40°C, 1008 hours
Thermal Shock	MIL-STD-750: Method 1056 10 cycles; 0°C to 100°C; 5-minute dwell-time at each temperature; 10-sec (max) transfer time between temperature
Autoclave	EIA/JEDEC: JESD22-A102 168 hours (121°C at 2 ATMs) and 100% RH
Resistance to Solder Heat	MIL-STD-750: Method 2031 260°C, 10 seconds
Solderability	ANSI/J-STD-002: Category 3, Test A
Repetitive Surge Life Testing	Multi firings per half cycle at 60Hz in application circuit for 168 hours minimum

Dimensions — DO-15 (G Package)

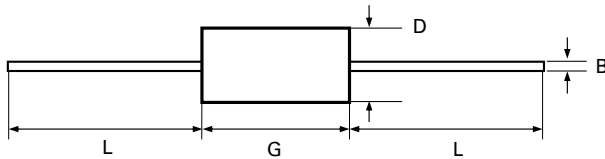

Dimension	Inches		Millimeters	
	Max	Max	Min	Max
B	0.028	0.034	0.711	0.864
D	0.120	0.140	3.048	3.556
G	0.235	0.270	5.969	6.858
L	1.000		25.400	

Product Selector

Part Number	Switching Voltage Range		Blocking Voltage	Packages
	V_{BO} Minimum	V_{BO} Maximum	V_{DRM}	
K2201G	200V	230V	180V	DO-15
K2401G	220V	250V	190V	DO-15
K2501G	240V	280V	200V	DO-15
K3601G	340V	380V	270V	DO-15

Packing Options

Part Number	Package	Packing Mode	Base Quantity
Kxxx1G	DO-15	Bulk	1000
Kxxx1GRP		Tape & Reel	5000

Note: xxx = voltage

DO-15 Embossed Carrier RP Specifications

Meets all EIA RS-29-6 Standards

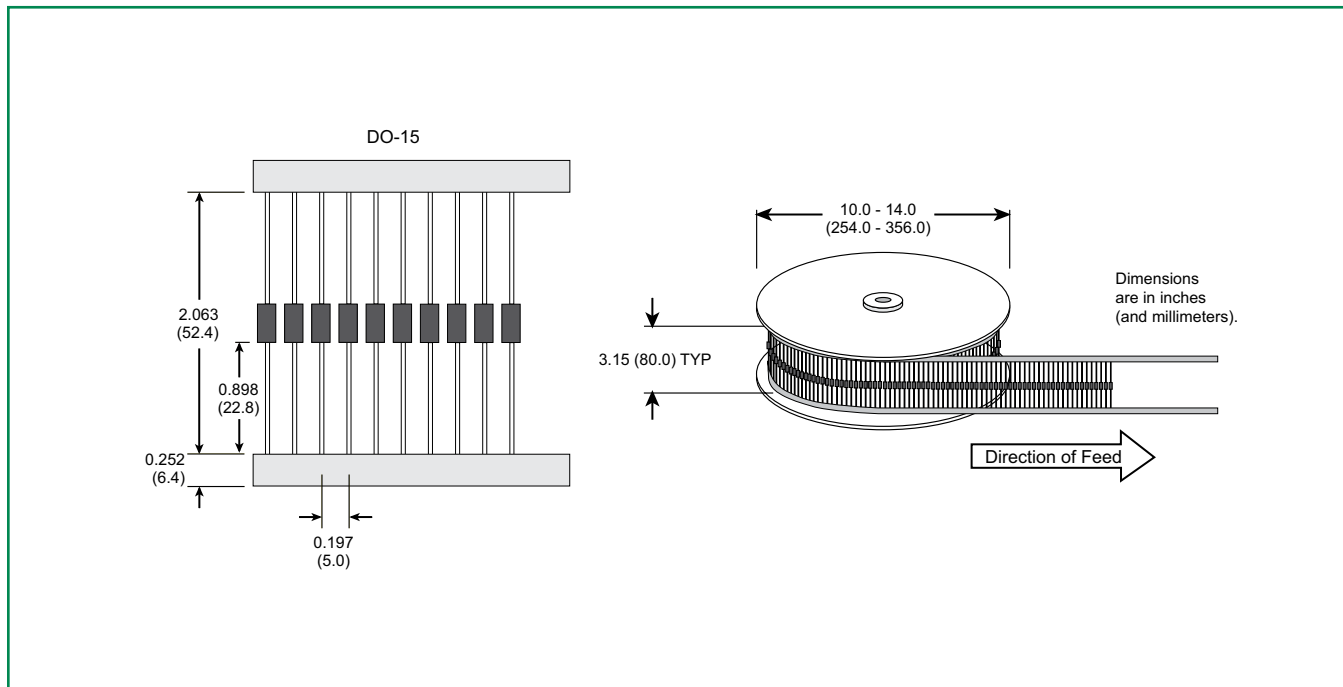

Part Numbering System

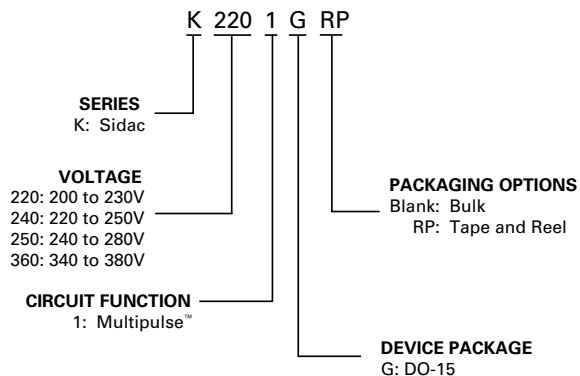

Part Marking System

